

# YOUR PERSPECTIVE

YOUR FUTURE



WINDOWS AND DOORS



## A PROVEN BRAND SINCE 1993

---

VIDOK is a company with 25 years of experience in the production of wooden, PVC and aluminum windows and doors. The motive of the brand is the passion to the craftsmanship inspired by modern technology as well as the passion to beauty. Since the beginning of the company's activity, the production of the highest quality doors and windows, without tolerating any compromises, was the key to the success.

Our experts provide modern product solutions and professional advisory beginning with the project phase, through the selection of the appropriate product, up to a professional installation. They individually select the latest technological solutions in compliance with the current construction regulations, norms and market requirements.

As a world-wide recognized brand, we know how important the complexity is for the customer, the complexity which combines the best product together with the highest quality service. We aim for excellence, we constantly develop, expand our horizons in harmony with the latest trends. In order to achieve the highest quality, our qualified employees diligently perform the aim for excellence. We focus our actions on the cooperation with the best suppliers of solid, modern materials and systems which are widely appreciated on the European market.

VIDOK has been sharing the satisfaction of business partners and customers for many years. It is reflected in the constant development and expansion of the activity to a global scale. Our solutions accompany customers every day; therefore it is so important for us to create windows which we would like to have in our own houses.

We wish to encourage you to get familiarized with our quality by cooperating with us and we would like to derive satisfaction from purchasing our products.

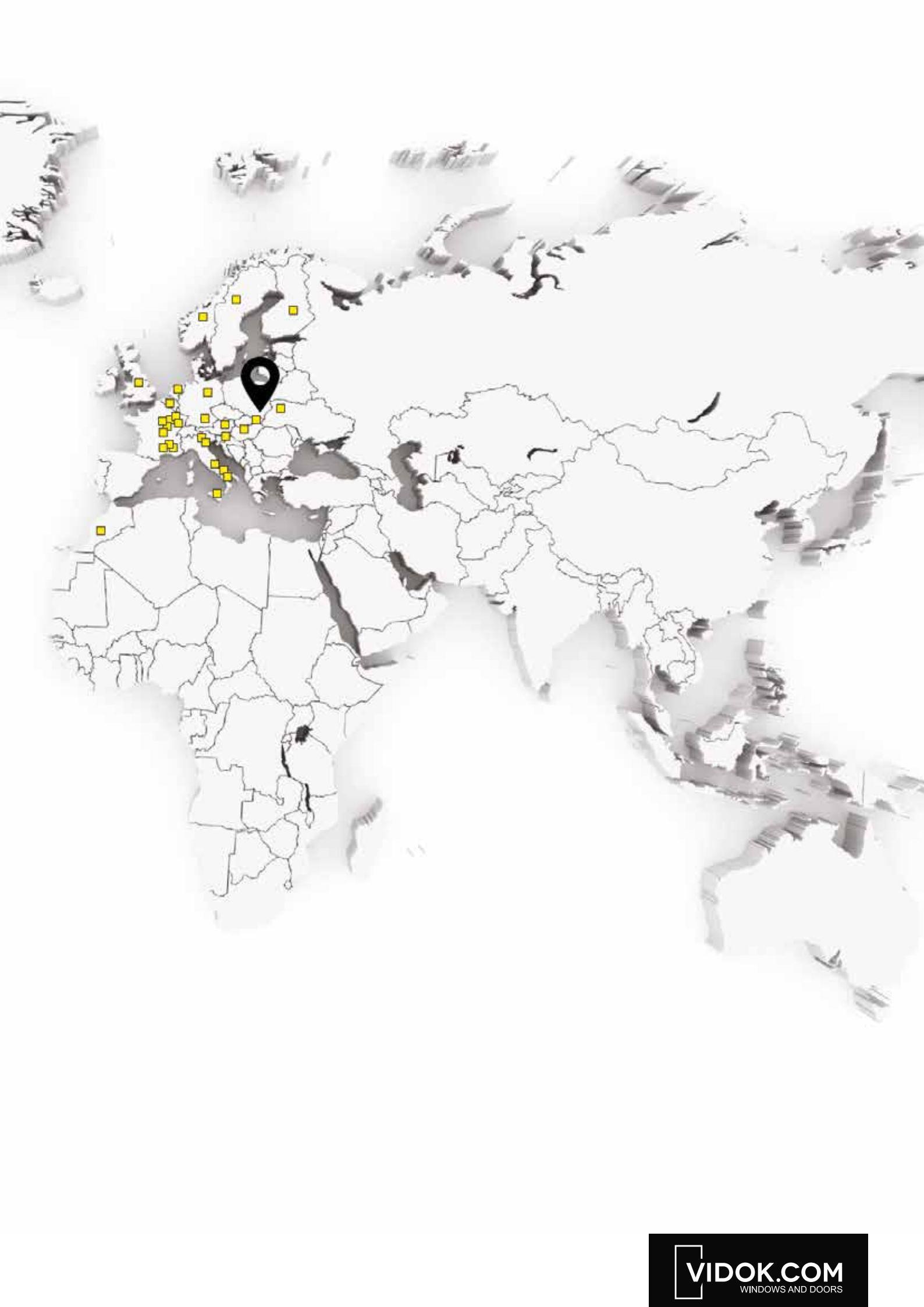



## TABLE OF CONTENTS

---

|                          |    |
|--------------------------|----|
| OUR STRENGTHS            | 6  |
| TECHNOLOGY               | 8  |
| SECURITY                 | 10 |
| AESTHETICS               | 12 |
| COMFORT                  | 14 |
| WINDOW SYSTEMS           | 16 |
| WOODEN WINDOWS           | 18 |
| WOOD – ALUMINUM WINDOWS  | 24 |
| PVC/PVC+AL WINDOWS       | 34 |
| ALUMINUM WINDOWS         | 48 |
| SLIDING DOORS            | 52 |
| EXTERNAL ROLLER SHUTTERS | 56 |
| SMART VIDOK              | 64 |
| SCREEN ROLLER BLINDS     | 66 |
| FACADE SHUTTERS          | 67 |
| HANDLES                  | 70 |
| GLAZING                  | 72 |
| WHY IS IT WORTH IT?      | 76 |
| CERTIFICATES, AWARDS     | 77 |
| OUR PARTNERS             | 77 |
| IMPRESSUM                | 77 |

# OUR STRENGTHS

---

Energy efficiency, durability, security, acoustics, comfort and design are the assets of our products, which will add a character and increase the value of your investment.

## ENERGY EFFICIENCY

Build with us in a reliable way and save. Our technologically advanced solutions with the application of triple glazing of the coefficient of  $0,6 \text{ W/m}^2\text{K}$  guarantees energy efficiency and lowers your household expenditures. Gain even more choosing the  $0,5 \text{ W/m}^2\text{K}$  glass with a TGI warm frame.

## INNOVATION

Thanks to possessing our own research-development center we constantly improve our products. While using the best materials and implementing the most recent technology, we create unique solutions, which are appreciated by customers and experts worldwide.

## ACOUSTICS

Windows are an element which has a huge impact on your house acoustic isolation. Thanks to using the right profile system, soundproof glass, seals and the right installation technology you will simply feel silence... The parameter which is possible to achieve is 47 dB.

## DESIGN

Windows and doors are a satisfaction of each house. When properly designed, they add a character and attractivity. Sensitiveness to details and the precision of the manufacture are our assets, which allows to create products which suit the taste of the fans of even the most sophisticated styles.



## SECURITY

Secure your house with VIDOK windows, protect yourself and your family. Use our security package with an anti-burglar system, as well as security and comfort of use. We shall select appropriate glass, fittings, handles and installation technology to meet your requirements.

## PROFESSIONAL INSTALLATION

Each product requires a professional installation. The right installation guarantees functionality and durability for many years. Even the highest quality windows may lose their properties due to inappropriate installation. Trust our VIDOK experts who pay special attention to all aspects of woodwork installation at the designing stage.

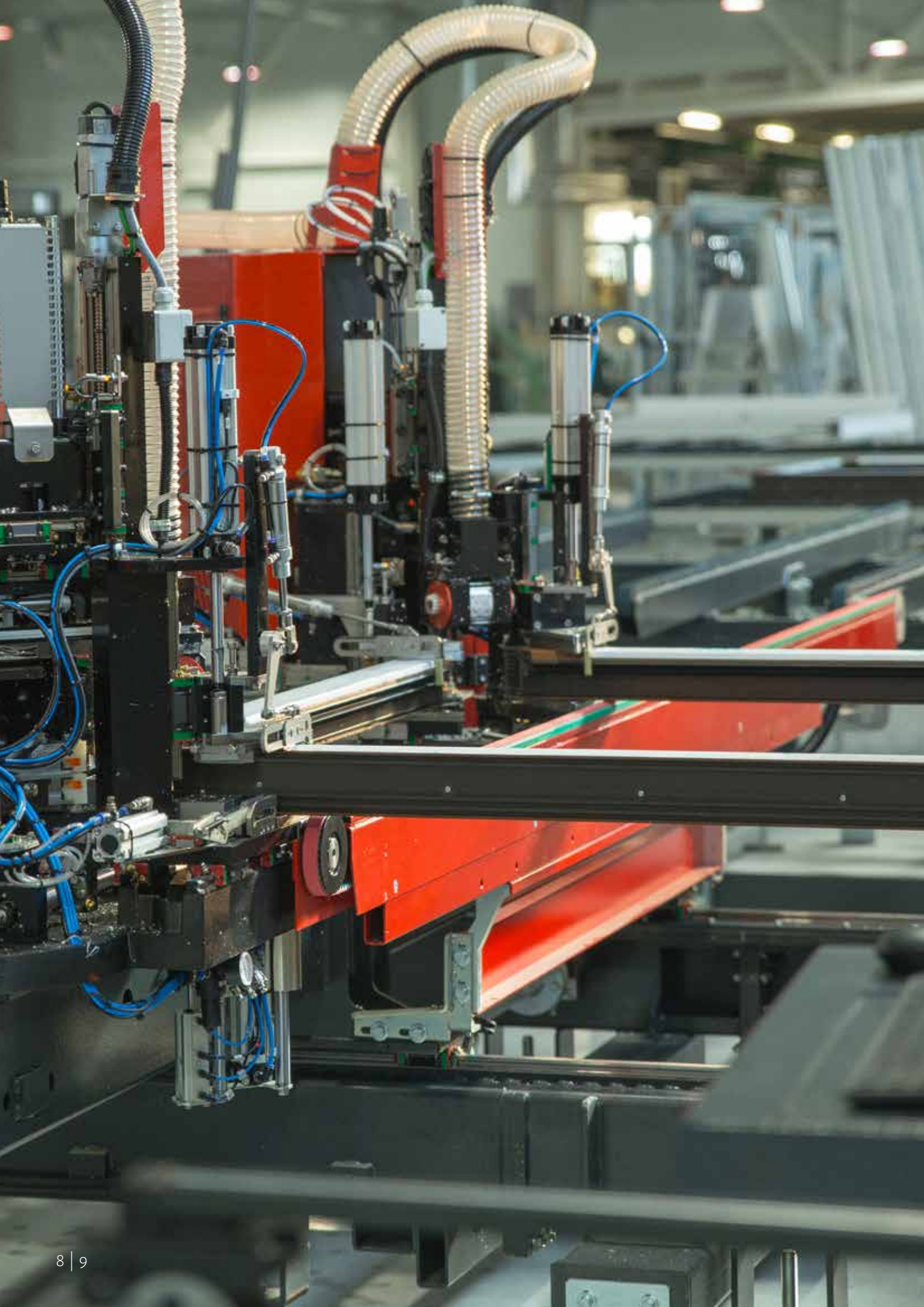





## TECHNOLOGY

---

The unique product requires advanced technology. The secret lies in the heart of robots and the new generation of numerically controlled machines. With the great precision they shape the smallest details of produced joinery.

Using innovative methods, in the way previously unattainable they create seamless seams in PVC windows and care for the smallest elements of finish in wooden.

The highest quality, however, would not be possible without the experience and knowledge of our experts who conscientiously carry out the strategy of striving for the ideal products. All this with the participation of high qualified VIDOK engineers. In the research and development center they contribute to achieve the best parameters and features. Our products are controlled by the most severe endurance tests such as resistance to wind, rain or solar radiation. Regular quality control, surveys, tests and inspections are the quality standards of VIDOK.

---



160 km/h

window's resistance to  
wind load



15000

full opening and closing  
cycles of sliding doors



70°

resistance to heating





## SECURITY

---

It is worth thinking about your house protection at the stage of designing it. At present times, the sense of security is one of the main needs of each person. It has a significant impact on the comfort and quality of life. First of all, windows and doors should be properly protected against burglary using appropriate anti-burglar systems. The right combinations of fittings (RC) in connection with laminated glass (VSG) and a lockable handle guarantees the best protection of your house. There are a few resistance categories (RC) which are regulated by the European Norm. The higher the category, the more efficient protection.

---



**RC2**

burglary resistance class



**300 kg**

the pressure





## AESTHETICS

---

Windows and doors are not just a part of the building. They are an important element of interior design that significantly increases its attractiveness and adds character to it. A wide spectrum of system solutions in all possible kinds of wood, PVC and aluminum allows the window and door joinery to achieve almost all of investor's individual expectations. An impressive range of finishing types, from the texture and color of profiles, through glazing types to combinations of warm frames and gaskets and sophisticated accessories in the form of stylish handles or covered Designo fittings add an individual style to every space.

---



600

the most fashionable  
colors



3500

configurations and  
solutions in all materials





## COMFORT

---

The functionality and convenience resulting from the using of windows and doors are extremely important. Therefore often they become the main factor of choice. VIDOK attaches great importance to this aspect. Each of our solutions are specially selected to meet the specific needs of the investor.

Do you need decorative glass in the bathroom? Do you need sunprotection or safety glass in your rooms? Do you live by the sea and need fittings resistant to salt corrosion? Do you live in noisy environments, close to busy roads or particularly noise polluted areas, and want to have windows with high noise reduction?

Tell us what you need and we will transform your needs into unlimited pleasure form of living full life in your home.

---



up to **48** dB



the highest class -  
the lowest value of  
the operating forces  
necessary to open the  
window



fittings with increased  
resistance to salinity

# THE BEST SOLUTIONS AT ONE EXPERT

---



## WOODEN WINDOWS

---

### PERFECT FOR INDIVIDUALISTS

Natural wood beauty and a high manufacture precision match the tastes of people valuing individuality and admiring unique styles.



## WOOD-ALUMINUM WINDOWS

---

### IDEAL FOR THE DEMANDING

A harmonic combination of wood and aluminum creates natural warmth from the inside and exceptional durability outside adapting into the latest trends of the world architecture.



### ACOUSTIC ISOLATION

RA2 = 42 dB,  
RA2 36 dB with air vent



### ENERGY EFFICIENCY

Dedicated for passive houses





## PVC/PVC+AL WINDOWS

---

### UNIQUE SOLUTIONS

Innovative, durable and reliable solutions for modern construction, created based on advanced technology and perfect finishing details.



## ALUMINUM WINDOWS

---

### CREATING MODERNITY

A modern style and a wide design spectrum of experimental architecture.



**THE HIGHEST QUALITY CLASS „A”**  
meeting the highest standards  
RAL (PN-EN 12608).



**SECURITY**  
Resistance class RC-2





## WOODEN WINDOWS

### PERFECT FOR INDIVIDUALISTS

---

Dedicated for all those valuing naturalness and timeless elegance. They add warmth and character to each house interior. Wooden windows are the highest quality products which fulfil the latest requirements and European standards. They are created exclusively based on selected, appropriately glued timber. This multi-layer construction guarantees stability and resistance to deformations. Appropriate preservation, staining and the coats of varnish guarantee a long-lasting life cycle. The natural wood structure is highlighted by transparent varnishes, with a wide range of colors gives you freedom for the interior decorations and the façade design. Wooden windows perfectly adapt to both modern, minimalistic interiors, as well as stylish, elegant ones which are valued by the followers of a more sophisticated taste.

# VD-68

## WOOD

### PROFILE

Installation depth – 68 mm

### CONSTRUCTION

A single-frame construction of the casement and frame depth of 68 mm

### COLOUR

Transparent or solid colors according to the RAL range

### FITTINGS

Multi-point locking fittings of an increased anti-corrosion protection, optional Designo fitting, RC2 anti-burglar, Tilt-First

### SEALS

Three replaceable seals

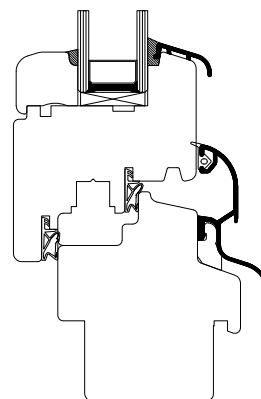

### PROPERTIES

THERMAL INSULATION



$U_w = 1,25 \text{ W/m}^2\text{K}^*$

ACOUSTIC ISOLATION



up to 44 dB

\*applies to the reference window 1,23 m x 1,48 m  
 $U_g = 1,0 \text{ W/m}^2\text{K}$

# VD-78

## WOOD

### PROFILE

Installation depth – 78 mm

### CONSTRUCTION

A single-frame construction of the casement and frame depth of 78 mm

### COLOUR

Transparent or solid colors according to the RAL range

### FITTINGS



Multi-point locking fittings of an increased anti-corrosion protection, optional Designo fitting, RC2 anti-burglar, Tilt-First

### SEALS

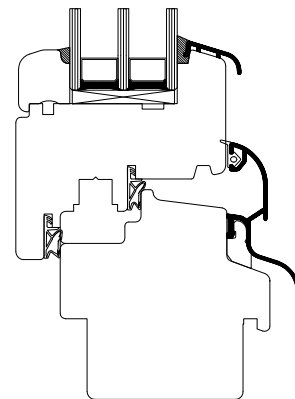
Three replaceable seals



### PROPERTIES

|                    |   |                                      |
|--------------------|---|--------------------------------------|
| THERMAL INSULATION |  | $U_w = 0,86 \text{ W/m}^2\text{K}^*$ |
| ACOUSTIC ISOLATION |  | up to 48 dB                          |
| RESISTANCE CLASS   |  | RC2                                  |

\*applies to the reference window 1,23 m x 1,48 m  
 $U_g = 1,0 \text{ W/m}^2\text{K}$

# VD-92

## WOOD

### PROFILE

Installation depth – 92 mm

### CONSTRUCTION

A single-frame construction of the casement and frame depth of 92 mm

### COLOUR

Transparent or solid colors according to the RAL range

### FITTINGS

Multi-point locking fittings of an increased anti-corrosion protection, optional Designo fitting, RC2 anti-burglar, Tilt-First

### SEALS

Three replaceable seals

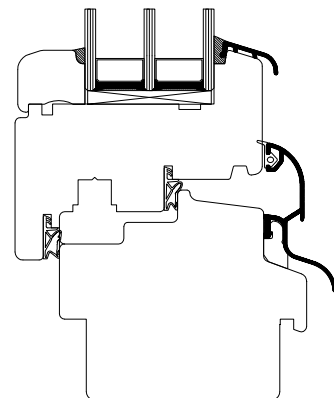

### PROPERTIES

THERMAL INSULATION



$U_w = 0,76 \text{ W/m}^2\text{K}^*$

ACOUSTIC ISOLATION



up to 48 dB

RESISTANCE CLASS



RC2

\*applies to the reference window 1,23 m x 1,48 m  
 $U_g = 0,5 \text{ W/m}^2\text{K}$









## WOOD-ALUMINUM WINDOWS

IDEAL FOR THE DEMANDING

---

A perfect quality and finish. They combine naturalness and inside warmth of the wood with modernity and exceptional aluminum durability. Innovative solutions for those who demand more, value the highest quality and sophisticated beauty. In comparison to wooden windows, they are characterized by longer durability, better technical parameters, performance properties, as well as significantly higher resistance to weather conditions.

A wide range of colors and structures of aluminum overlays provides unlimited possibilities in designing and realizing even the most courageous designs, being part of the world trends of modern architecture.

# VDA – 84

## WOOD- ALUMINUM

**PROFILE** Installation depth: 68/84 mm

**CONSTRUCTION** A combination of wood and aluminum

**WOOD COLOUR** Transparent or solid colors according to the RAL range

**ALUMINIUM COLOUR** Anodized or varnished colours, special colors chart

**FITTINGS** Multi-point locking fittings of an increased anti-corrosion protection, optional Designo fitting, RC2 anti-burglar, Tilt-First

**SEALS** Four replaceable seals

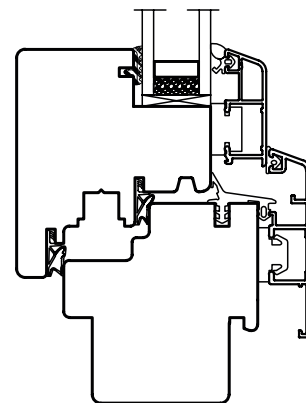

### PROPERTIES

THERMAL INSULATION



$U_w = 1,25 \text{ W/m}^2\text{K}^*$

ACOUSTIC ISOLATION



up to 44 dB

\*applies to the reference window 1,23 m x 1,48 m  
 $U_g = 1,0 \text{ W/m}^2\text{K}$

# VDA-94

## WOOD-ALUMINUM

**PROFILE** Installation depth: 78/94 mm

**CONSTRUCTION** A combination of wood and aluminum

**WOOD COLOUR** Transparent or solid colors according to the RAL range

**ALUMINIUM COLOUR** Anodized or varnished colours, special colors chart

**FITTINGS** Multi-point locking fittings of an increased anti-corrosion protection, optional Designo fitting, RC2 anti-burglar, Tilt-First

**SEALS** Four replaceable seals

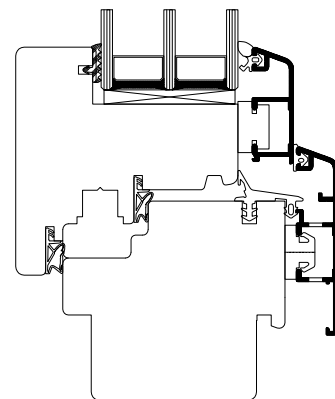

### PROPERTIES

THERMAL INSULATION



$U_w = 0,81 \text{ W/m}^2\text{K}^*$

ACOUSTIC ISOLATION



up to 48 dB

\*applies to the reference window 1,23 m x 1,48 m  
 $U_g = 0,5 \text{ W/m}^2\text{K}$

# VDA – 116 PASSIV

## WOOD- ALUMINUM

### PROFILE

Installation depth: 116 mm

### CONSTRUCTION

A combination of wood and aluminum with innovative isolation materials, it fulfils the requirements of passive construction

### WOOD COLOUR

Transparent or solid colors according to the RAL range

### ALUMINIUM COLOUR

Anodized or aluminum varnished colors, special colors chart

### FITTINGS



Multi-point locking fittings of an increased anti-corrosion protection, optional Designo fitting, RC2 anti-burglar, Tilt-First

### SEALS

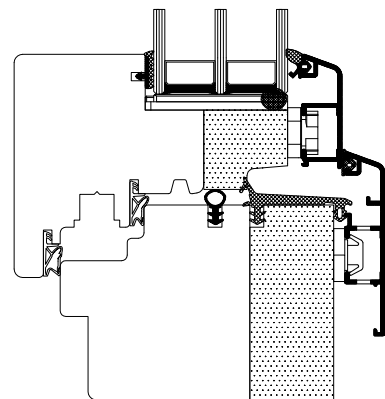
Five replaceable seals



### PROPERTIES

|                    |   |                                     |
|--------------------|---|-------------------------------------|
| THERMAL INSULATION |  | $U_w = ,67 \text{ W/m}^2\text{K}^*$ |
| ACOUSTIC ISOLATION |  | up to 48 dB                         |
| RESISTANCE CLASS   |  | RC2                                 |

\* applies to the reference window 1,23 m x 1,48 m  
 $U_g = 0,5 \text{ W/m}^2\text{K}$





## WOOD SPECIES

---

PINE



MERANTI



LARCH



OAK



## WOOD FINISHES

---

light oak

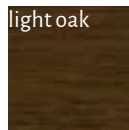

walnut



macore

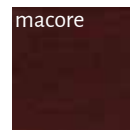

palisander



olive



pine



dark oak

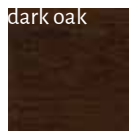

old pine



cypress

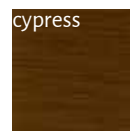

spruce

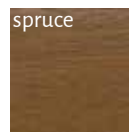

light cherry

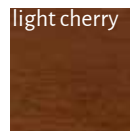

oak

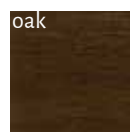

red cherry

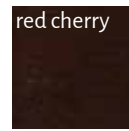

chestnut

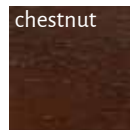

antique pine

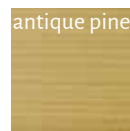











## PVC/ PVC+AL WINDOWS

### UNIQUE SOLUTIONS

---

A perfect combination of advanced technology with the highest comfort in use. Modern, safe solutions, impressing with their form and finish precision. They are based on carefully designed profiles in the highest A quality class, guaranteeing exceptional thermal and acoustic insulation. A multi-chamber construction together with internal steel reinforcements, modern insulation system and low-emission thermal insulation glass provide optimal weather and noise protection.

PVC windows are characterized by a long life-cycle and they are low maintenance. An original, harmonic design and a big selection of system solutions give almost unlimited possibilities in designing windows, highlighting the style and character of each investment. A wide range of colors and textures additionally increases the visual originality of the building.

# VP-70

PVC

## PROFILE

Installation depth: 70 mm,  
highest A class

## CONSTRUCTION

A 5-chamber profile of the outside  
wall depth of 2,8 mm, seamless  
welding

## COLOUR

White, wood-imitating, solid  
veneers according to the RAL  
range

## FITTINGS

Multi-point locking fittings of an  
increased anti-corrosion protection,  
optional Designo fitting, RC2 anti-  
burglar, Tilt-First

## SEALS

Two replaceable seals

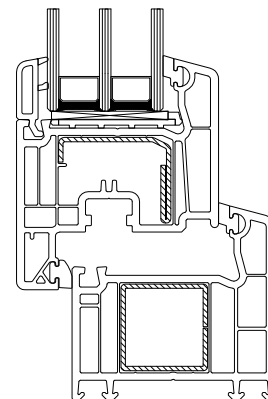

## PROPERTIES

THERMAL INSULATION



$U_w = 0,9 \text{ W/m}^2\text{K}^*$

ACOUSTIC ISOLATION



up to 48 dB

RESISTANCE CLASS



RC2

\*applies to the reference window 1,23 m x 1,48 m  
 $U_g = 0,6 \text{ W/m}^2\text{K}$

# VP-74

PVC

## PROFILE

Installation depth: 74 mm

## CONSTRUCTION

A 6-chamber profile, seamless welding

## COLOUR

White, wood-imitating, solid veneers according to the RAL range, anteak

## FITTINGS

Multi-point locking fittings of an increased anti-corrosion protection, optional Designo fitting, RC2 anti-burglar, Tilt-First

## SEALS

Due guarnizioni

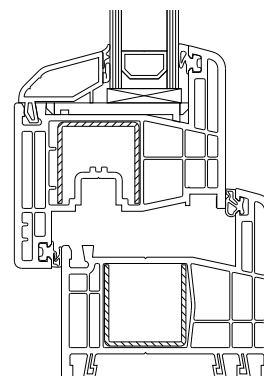

## PROPERTIES

THERMAL INSULATION



$U_w = 0,79 \text{ W/m}^2\text{K}^*$

ACOUSTIC ISOLATION



up to 44 dB

RESISTANCE CLASS



RC2

\* applies to the reference window 1,23 m x 1,48 m  
 $U_g = 1,0 \text{ W/m}^2\text{K}$



- 1 PVC profiles in the highest quality class „A“, meeting the highest RAL standards (PN-EN 12608).
- 2 Window profile with 7-chamber frame structure and 82mm installation depth, guaranteeing high efficiency energy (range from energy-efficient house to passive house).
- 3 Seamless weld made using the world’s only patented EVO technology.
- 4 An ultra-matt Spectral coating that impresses with its unique appearance, velvety and resistance for scratches.
- 5 Modern 3 X glass glazing packages with a warm TGI frame, improving glass tightness and properties insulating and preventing condensation on the edges of the glass.
- 6 Three gaskets with a central gasket with optimal geometry to protect against noise, cold and moisture. The high quality of the material ensures tightness and long life of the pvc joinery.
- 7 Designo fittings with a special ROTOSILK coating, equipped with anti-theft hitch, tilt lock, blocking incorrect position of the handle, micro ventilation and a stylish handle. They ensure comfort of use and security.
- 8 Simple, slim profiles in the original design.
- 9 Window handle in a variety of styles and colors.
- 10 Additional accessories: aluminum blinds, facade blinds, screen blinds, mosquito nets etc.

# VP – 82

PVC

## PROFILE

Installation depth: 82 mm,  
highest A class

## CONSTRUCTION

A 7-chamber frame construction of the  
outside wall depth of 2,8 mm, seamless  
welding

## COLOUR

Ultra-matte, white, wood-  
imitating, solid veneers according  
to the RAL range

## FITTINGS

Multi-point locking fittings of an  
increased anti-corrosion protection,  
optional Designo fitting, RC2 anti-  
burglar, Tilt-First

## SEALS

Three replaceable seals

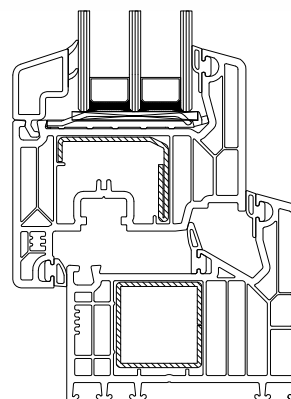

## PROPERTIES

THERMAL INSULATION



$U_w = 0,77 \text{ W/m}^2\text{K}^*$

ACOUSTIC ISOLATION



up to 48 dB

RESISTANCE CLASS



RC2

\*applies to the reference window 1,23 m x 1,48 m  
 $U_g = 0,5 \text{ W/m}^2\text{K}$

# VPA – 87

## PVC – ALUMINIUM

### PROFILE

Installation depth: 82/87 mm, highest A class

### CONSTRUCTION

A 7-chamber frame construction of the outside wall depth of 2,8 mm, seamless welding

### PVC COLOUR

White, wood-imitating, solid veneers according to the RAL range

### ALUMINIUM COLOUR

Special colors chart

### FITTINGS

Multi-point locking fittings of an increased anti-corrosion protection, optional Designo fitting, RC2 anti-burglar, Tilt-First

### SEALS

Three replaceable seals

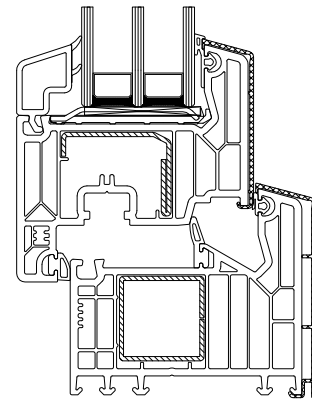

### PROPERTIES

THERMAL INSULATION



$U_w = 0,77 \text{ W/m}^2\text{K}^*$

ACOUSTIC ISOLATION



up to 48 dB

RESISTANCE CLASS



RC2

\*applies to the reference window 1,23 m x 1,48 m  
 $U_g = 0,5 \text{ W/m}^2\text{K}$

# VP – 83 LX

PVC

## PROFILE

Installation depth: 83 mm,

## CONSTRUCTION

A 6-chamber frame construction, seamless welding

## COLOUR

White, wood-imitating, solid veneers according to the RAL range, acrycolor, anteak

## FITTINGS



Multi-point locking fittings of an increased anti-corrosion protection, optional Designo fitting, RC2 anti-burglar, Tilt-First

## SEALS

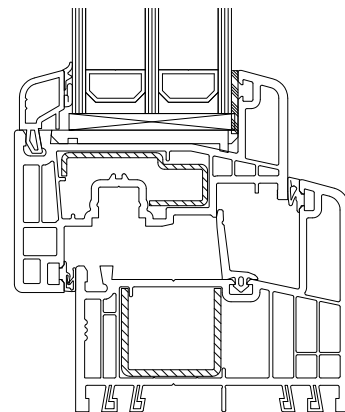
Three replaceable seals



## PROPERTIES

|                    |   |                                    |
|--------------------|---|------------------------------------|
| THERMAL INSULATION |  | $U_w=0,80 \text{ W/m}^2\text{K}^*$ |
| ACOUSTIC ISOLATION |  | up to 48 dB                        |
| RESISTANCE CLASS   |  | RC2                                |

\*applies to the reference window 1,23 m x 1,48 m  
 $U_g=0,5 \text{ W/m}^2\text{K}$





\*applies to reference window 1.23m x 1.48m Ug=0.5 W/m<sup>2</sup>K TGI

## VP 83 EXTREME

- 1 6-chamber profiles with foam insulation filling Profile with a depth of 83 mm, meeting the highest thermal insulation requirements
- 2 STV® Technology - dry gluing glass panes and window profiles
- 3 IKD® Technology - foam insulation filling inside chambers of profiles
- 4 AcrylColor Technology
- 5 Modern glass panes (triple glazing) with warm TGI spacers improving thermal insulation properties even more
- 6 Set of three gaskets
- 7 Designo fittings with special ROTOSILK coating including anti-burglar catch, tilt lock, protection against wrong handle position, microventilation and stylish handle
- 8 Straight smooth profiles with unique design

# VP-83 EXTREME

PVC

**PROFILE** • 83 mm depth

**CONSTRUCTION** • 6-chambers profile construction with IKD foam insulation filling, STV dry glazing, seamless welding

**COLORS** • White, wood imitating, solid according RAL, AcrylColor<sup>NEW</sup>

**FITTINGS** • Multi-point locking fittings of an increased anti-corrosion protection, optional Designo fittings, anti-burglar RC2, Tilt-First

**GASKETS** • Three replaceable gaskets

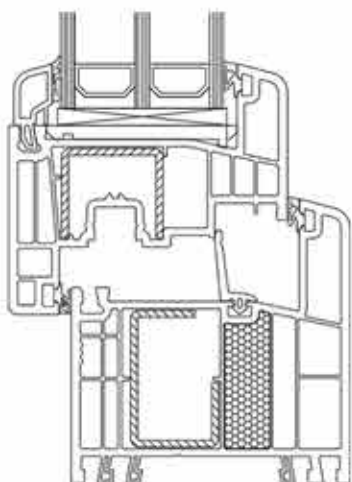

HEAT TRANSFER  
COEFFICIENT

$U_w = 0,74 \text{ W/m}^2\text{K}^*$



ACOUSTIC ISOLATION

do 48 dB



RESISTANCE CLASS

RC2

\*Applies to reference window 1,23m x 1,48m Ug=0,5 W/m2K TC3

## STV® TECHNOLOGY

---



STV® technology (dry static glazing) is an innovative method of dry gluing window panes to the profile of the sash. Taken from the aviation industry, used to connect the high-resistance aircraft constructions for material consumption. As a result of connecting the pane with the profile of the wing, the statics of the glass pane are transferred to the wing, significantly improving the strength of the structure. This allows the implementation of large-sized glazing, perfectly fitting into the modern interior design trends. Opening and closing windows is more comfortable. Moreover the window is resistant to forcing - technology provide extra anti-burglar protection.

## IKD® TECHNOLOGY

---

IKD® technology - innovative use of foam filling in the window profiles chamber at the stage of their extrusion. The foam has favorable thermal insulation parameters, which allows to produce windows and doors that meet the highest thermal requirements - from energy-saving to passive house standards.

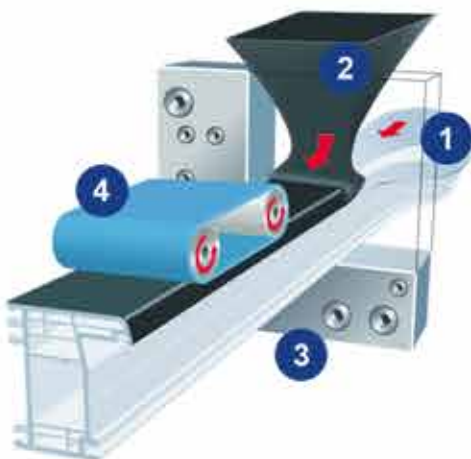
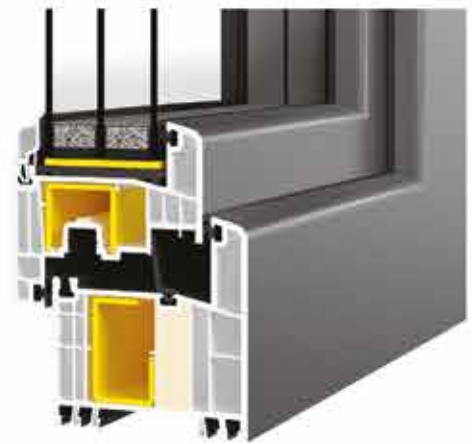

## ACRYLCOLOR TECHNOLOGY

---

AcrylColor technology is a unique method of producing window profiles guaranteeing the highest durability of their colors. The windows on the outside have a protective coating made of acrylic glass, the most durable plastic in the world. Submarine's windows or plane cockpits are usually made from this material. The thick coating is permanently combined with white PVC and is an effective barrier to external factors such as sun or hail. Profiles with AcrylColor coating absorb much less sunlight than traditional ones. This translates into longer color life and minimizes the risk of discoloration caused by UV rays. A wide spectrum of AcrylColor colors give you unlimited possibilities in creating any space.





# PVC FINISHES

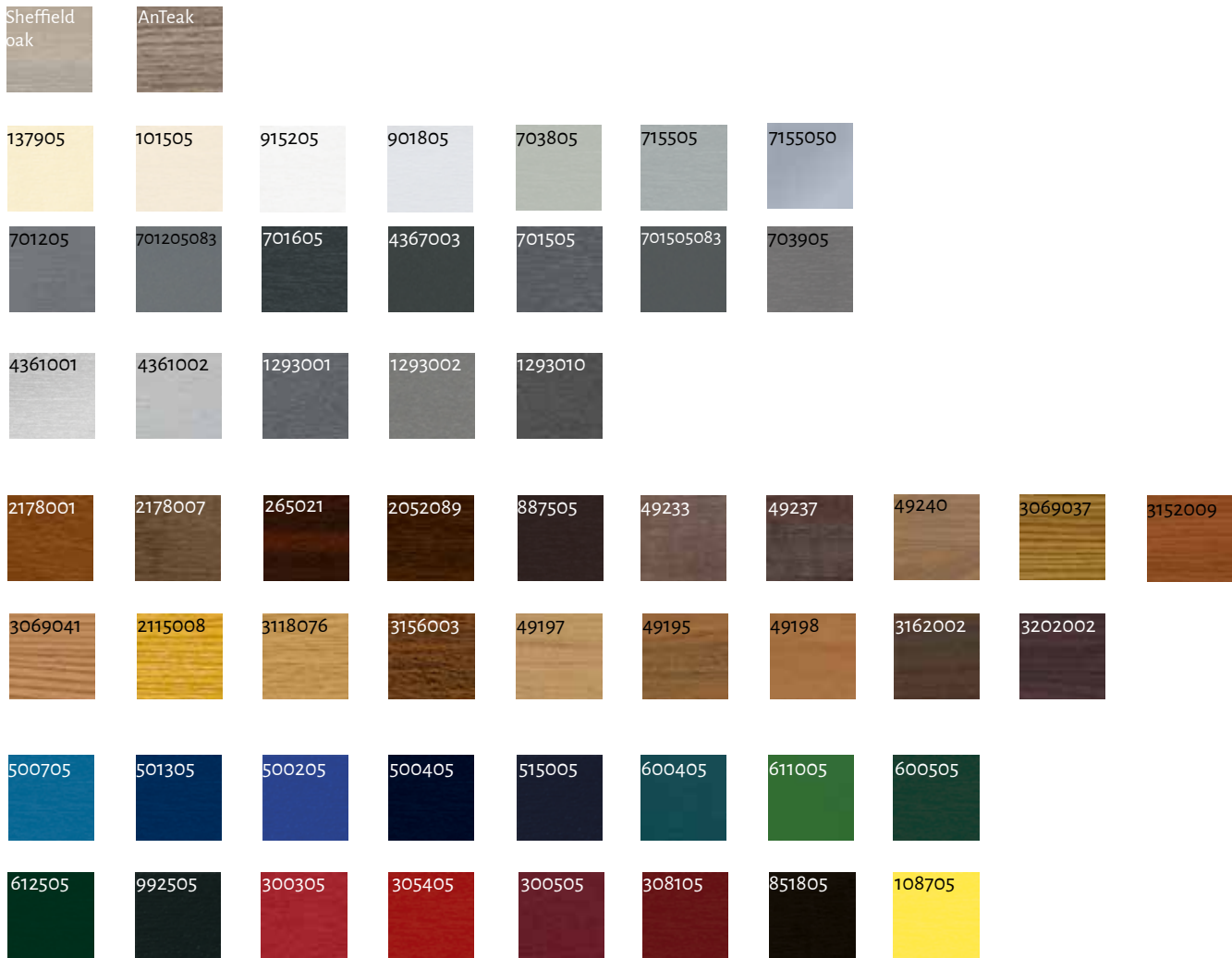

## ULTRAMAT



## ACRYLCOLOR







## ALUMINUM WINDOWS

### CREATING MODERNITY

---

The synergy of glass and aluminum dedicated to the most recent architectural solutions, where the scale and courage are combined together with minimalism and clarity of forms.

Aluminum constructions are produced based on technologically advanced profiles, used for the productions of facades, windows and doors and untypical spatial forms. The systems are designed for both external solutions, as well as inside rooms. Their multitude makes each construction to be created individually, in compliance with the project requirements and investor's expectations.

The advantage of aluminum constructions is their stability, long life cycle and resistance to weather conditions. Aluminum profiles can be anodized, painted or covered with foil imitating wood.

Aluminum is used in modern passive houses as well as large facilities, such as hotels, galleries, schools and airports.



# VA – 86 AERO

## ALUMINIUM

### PROFILE

Installation depth: 77/86 mm

### CONSTRUCTION

Aluminum construction with chamber thermal insulators with AEROGEL

### COLOUR

Anodized or varnished colors, RAL colour chart

### FITTINGS

Multi-point locking fittings of an increased anti-corrosion protection, optional Designo fitting, RC2 anti-burglar, Tilt-First

### SEALS

Multi component central

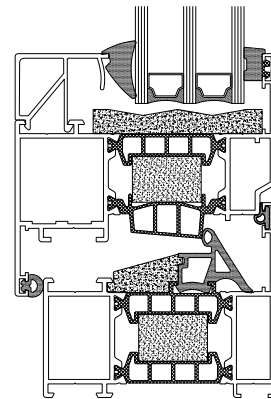

### PROPERTIES

THERMAL INSULATION



$U_w = 0,8 \text{ W/m}^2\text{K}^*$

ACOUSTIC ISOLATION



up to 48 dB

RESISTANCE CLASS



RC1/RC2

\*applies to the reference window 1,23 m x 1,48 m  
 $U_g = 0,5 \text{ W/m}^2\text{K}$

# VA-104 HI PASSIV

## ALUMINIUM

### PROFILE

Installation depth: 95/104 mm

### CONSTRUCTION

Aluminum construction with a special insulation fulfilling the requirements of passive constructions

### COLOUR

Anodized or varnished colours, RAL colour chart

### FITTINGS

Multi-point locking fittings of an increased anti-corrosion protection, optional Designo fitting, RC2 anti-burglar, Tilt-First

### SEALS

Multi component central

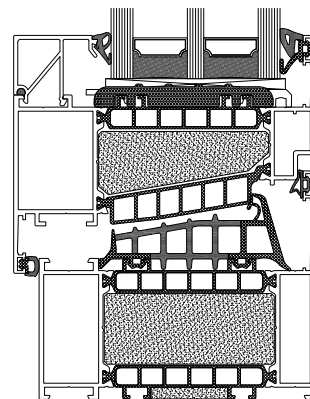

### PROPERTIES

THERMAL INSULATION



$U_w = 0,68 \text{ W/m}^2\text{K}^*$

ACOUSTIC ISOLATION



up to 48 dB

RESISTANCE CLASS



RC1

\* applies to the reference window 1,23 m x 1,48 m  
 $U_g = 0,5 \text{ W/m}^2\text{K}$





## SLIDING DOORS

### MODERNITY AND DESIGN

---

Patio sliding doors ideally fit into the trend of modern interior decorations. They add charm to the building façade, they give lots of light to the rooms and make the border between interior and exterior invisible.

The multitude of solutions of different technical complexity allows to adjust each construction to the investor's individual expectations. The special door construction gives a possibility to create impressive glazing. Thanks to the advanced technology, the door, regardless of their size, slide easily, saving the space at the same time. Doorsill-free solutions enable access to the patio without barriers, improving the comfort of use for the residents.

# V-SLIDE DOORS

---

- PROFILE:** PVC with an outer wall thickness of 3 mm (with maximum deviation only - 0.2 mm), meeting the requirements of PN-EN 12608 imposed on profiles  
The highest quality
- CONSTRUCTION:** 7-chamber frame structure, 6-chamber sash with the use of a chamber reinforcing and steel profiles that stiffen the structure.  
The doorstep with a wing has a cross-section of 156 mm, while the frame with sash gives a total dimension of 169 mm
- GLAZING:** combined glazing unit with low-emission glass and space up to 52 mm thick, optional safety glass, anti-burglar glass, sound absorbing glass, etc., „warm edge spacer bar” joining a glazing unit with a special PVC filled coating hygroscopic granulate, reducing condensation on the edges of windows
- WINDOW FITTINGS:** Enabling the combination of two-, three- and four-leaf terrace doors.  
The wings, depending on the needs, can be unopened or lifted and sliding.  
The fittings use roller bearings and teflon slides, thanks to which opening and closing, even large wings, is easy and requires no physical effort
- SEALS:** the seal system ensures that the door remains airtight, even under such loads as hurricane wind and heavy rain. Seals are practically invisible and constitute optimal acoustic protection

## DOOR DIAGRAMS:

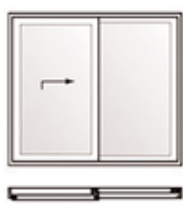

Scheme A



Scheme D



Scheme CW



Scheme C

# OPEN TO THE FULL OF COMFORT VIEW

---

Terrace doors are an important element of space arrangement. The luxurious design of the system makes the interior gain aesthetics, and using the terrace is more comfortable than ever.



## SPACE WITHOUT BARRIERS

V-SLIDE is equipped with a comfortable, low threshold allowing unlimited access without barriers. His duothermic separation ensures zone separation inside from outside, without thermal bridges, and protects the interior against cold, noise and heavy rain . When the door is open, the threshold is not a barrier, which allows unrestricted access, increasing the comfort of use.

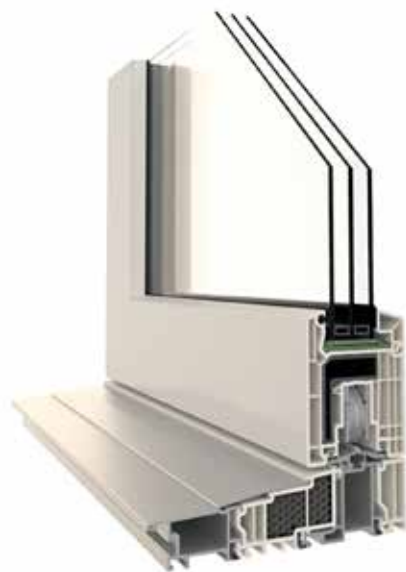
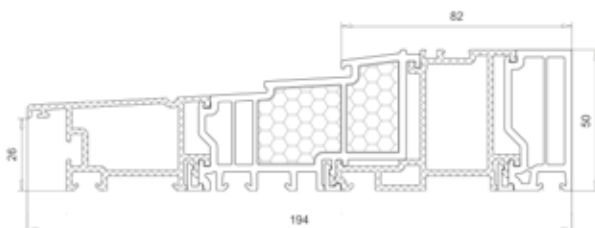





## EXTERNAL ROLLER BLINDS

### PROTECT YOUR PRIVACY

---

Roller blinds are not only external window and door covers. It is a fully automated, intelligent system, which provides an efficient protection against summer heat, noise, burglary, heat loss, wind, rain, snow and frost.

Thanks to a perfect integration with the surrounding they have an impact on the building aesthetics, providing privacy and comfort. In a subtle way they change the atmosphere and interior design. They protect against the uncontrolled heat loss in the winter and excessive heat inside the rooms in the summer. Shut roller blinds efficiently stop “unwanted guests” and the additional security system constitutes protection against opening the blinds.

Roller-blinds system solutions are individually selected, depending on the building, type of installation and their fitting. Our systems are equipped with automatically operated SMART VIDOK enabling intelligent management of all roller blinds or a group of roller blinds from each place all over the world using a smartphone or tablet.



# ROLLER SHUTTER SYSTEMS

---

## PUTZ ROLLER SHUTTER

---

a system of new generation roller shutters. They eliminate thermal losses and thermal bridges in the building and they provide a perfect integration with the surroundings. They are dedicated for newly erected buildings. One needs to think about the Putz roller shutters at the stage of planning, as its mounting usually requires an appropriate intel, which would account for the installation of a roller-blind box. A different recommended method is making dilatations at the top of the windows. While choosing this solution, we need to remember about enlarging window openings. Such a solution eliminates the need to prepare special lintels and insulate them and it completely eliminates the occurrence of thermal bridges. The roller-blind box is invisible after plastering, whereas the revision flap made of extruded aluminium can be lacquered and veneered. This is the best available construction solution free from any defects.



## BECLEVER ROLLER SHUTTER

---

a universal system installed together with windows. It fulfils the requirements of the supporters of roller shutter not being built-up, being partially built-up and fully built-up. The roller-blind box is mounted together with windows, which to a great extent allows investors to save time connected with planning and installing roller shutters. The access is made easier, it opens from the inside of the room, from the top or from the bottom. Beclever roller shutters can be accompanied with mosquito nets installed in the boxes. This innovative solution in this field, being a result of several years of research works, is a response to the market's expectations.

## FLEXI ROLLER SHUTTER

---

a system, which due to the specificity of the construction is designed for using in buildings with existing woodworks. The roller shutter is mounted outside the building, on the facade or in the window opening. It has a visible box, which becomes a decorative element of the house. It is the most compatible roller shutter.





# PUTZ ROLLER SHUTTER

---

## THE WAY OF INSTALLING A PUTZ ROLLER SHUTTER

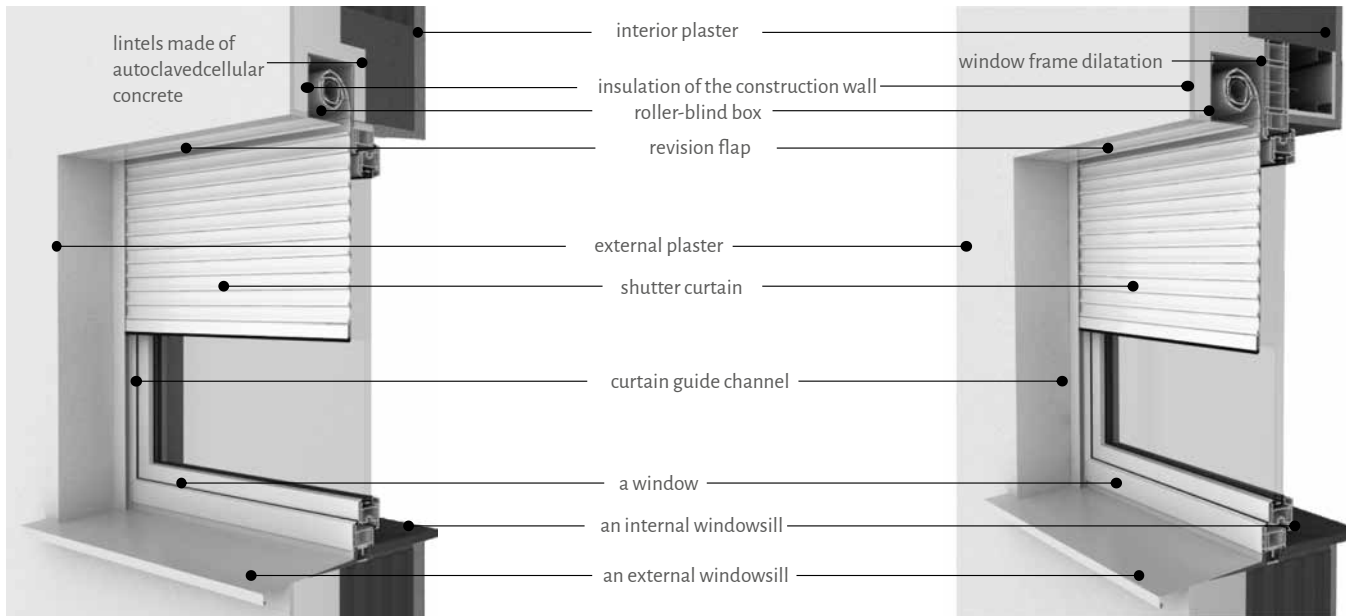

Five dimensions of the roller blind's box:  
137x137 mm, 150x150 mm, 165x165 mm, 180x180 mm, 205x205 mm.

An aesthetic access cover placed from the bottom of the roller shutter (access from the outside of the building).

The roller shutter is designed for a complete build-in, the lack of interference in the building's Appearance (architectonic cleanliness).

A possibility to paint visible elements of the roller shutter in any colour.

A possibility to insulate the roller-blind box with a Aluthermo Quattro® thermal cover.

## THE WAY OF INSTALLING A BECLEVER ROLLER SHUTTER

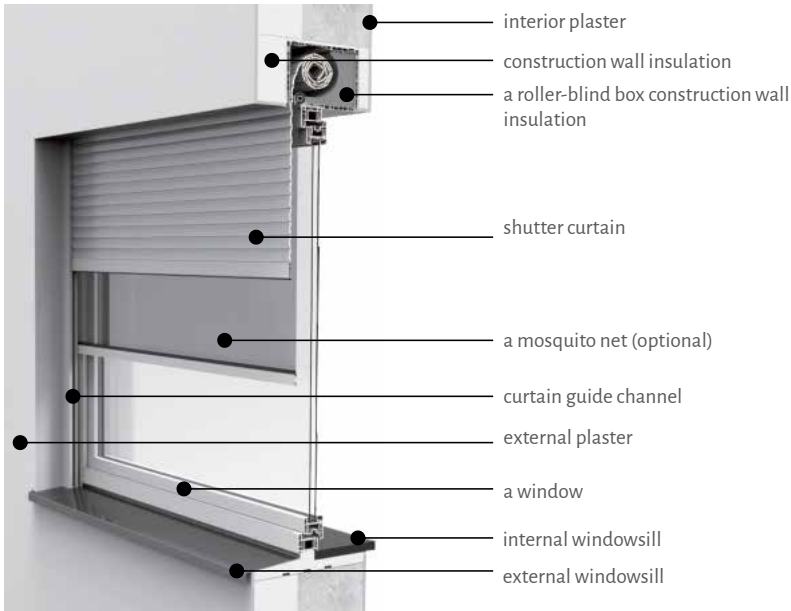

COMPLETE



EXTERNAL



NOT BUILT-UP



## A BUILD-UP OF A ROLLER-BLIND BOX

Three dimensions of the roller-blind box:  
255x165 mm, 255x205 mm, 255x245 mm.

The roller-blind box available in two versions: with a rolling mosquito net and without it.

A universal adaptation profile enabling an easy installation of the roller shutter on every window: PVC, wooden or aluminium.

An aesthetic access cover with a functional lock placed from the bottom or at the back of the roller-blind box.

Optional reinforcements and consoles providing stability of the construction even in case of big dimensions of roller shutters.

# FLEXI ROLLER SHUTTER

---

## THE WAY OF INSTALLING A FLEXI ROLLER SHUTTER

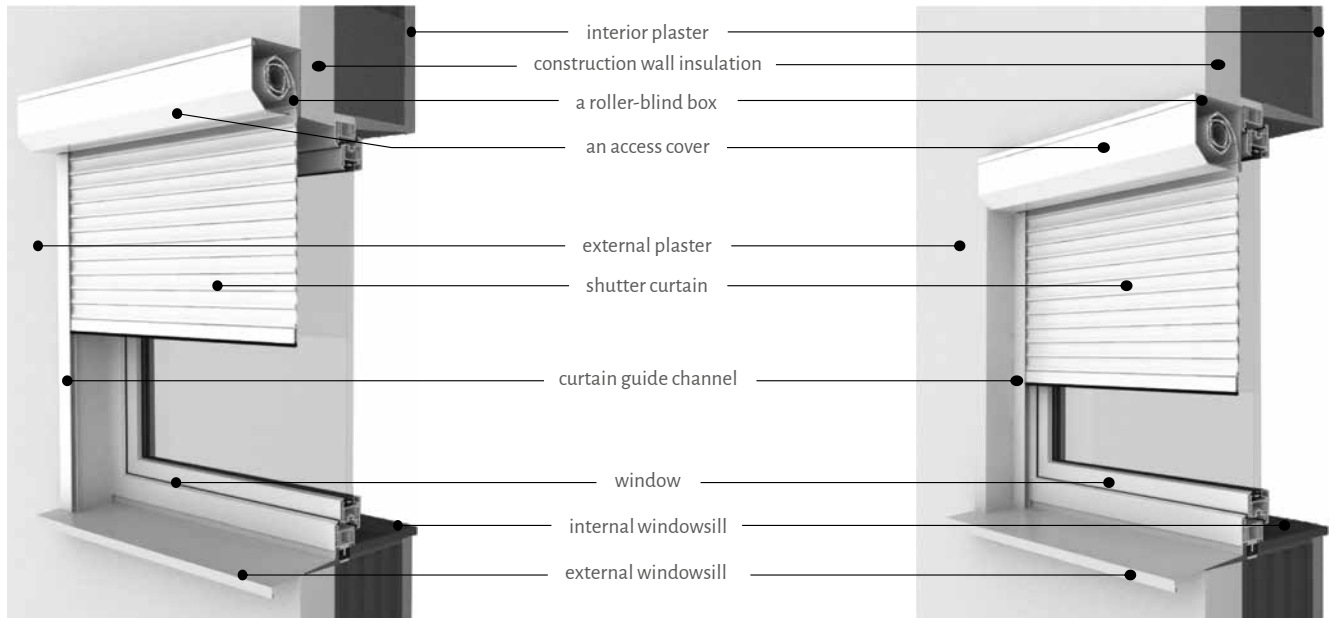

Five dimensions of the roller-blind box:

137x137 mm, 150x150 mm, 165x165 mm, 180x180 mm, 205x205 mm.

An aesthetic access cover placed from the bottom of the roller-blind box (access from the outside of the building).

Mainly used in the case of the modernisation of existing buildings.

The roller shutter is installed on the facade, without a possibility to build it in.

A possibility to install the roller shutter on a one-, two-, three- layer wall.

## COLOR PALETTE

---

The choice of colours is one of the most important aspect of a house decoration. It builds its style and character.

A wide range of the colours of roller shutters allows to choose their elements so that they perfectly go together with the building design.

To make everyone feel a unique atmosphere of their house, being in agreement with their taste and aesthetics.

01 white ± RAL 9010

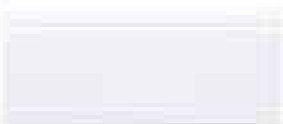

02 brown ± RAL 8077

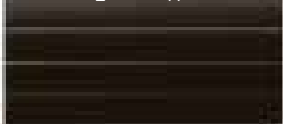

03 silver ± RAL 9006



04 grey ± RAL 7038

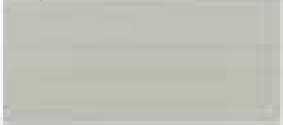

05 beige

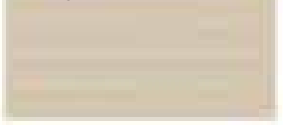

16 nut brown

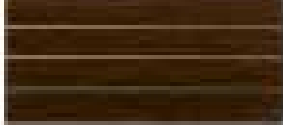

17 mahogany



19 marsh oak



25 dark beige ± RAL 1019



26 cream ± RAL 1015

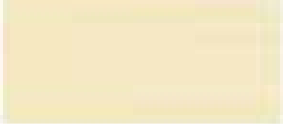

38 golden oak



39 winchester



64 light grey ± RAL 7035

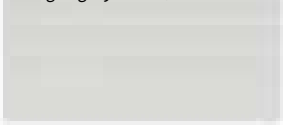

65 cream white ± RAL 9001

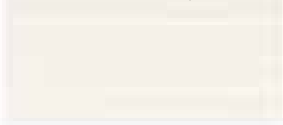

66 dark blue ± RAL 5011

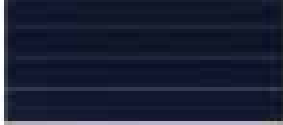

67 anthracite ± RAL 7016

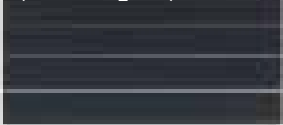

88 light brown ± RAL 8014



89 light cream ± RAL 1013

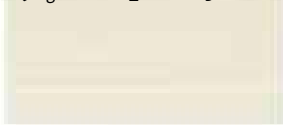

---

The colour samples presented above are for reference only and they might differ from the real colours.

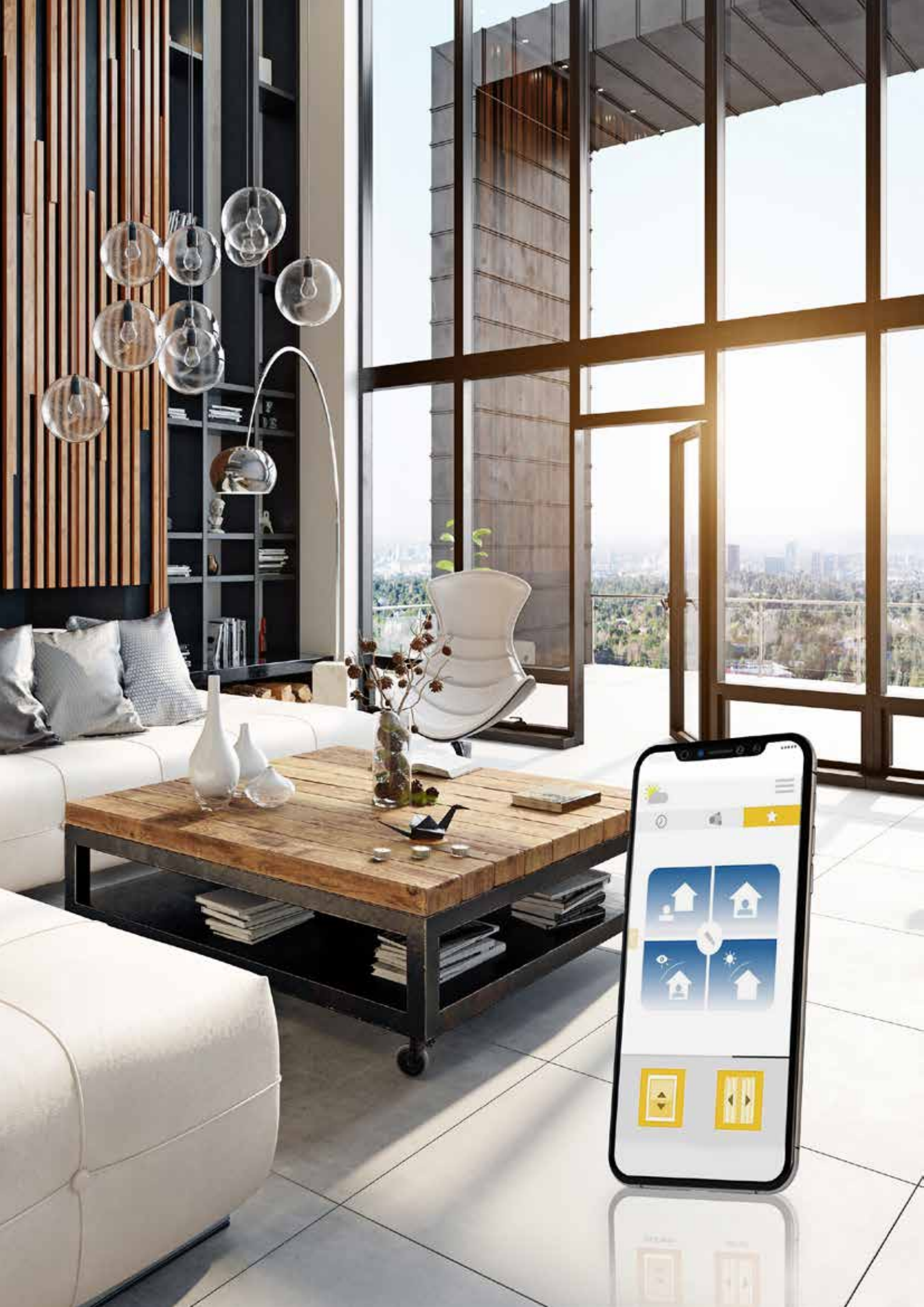

## AN INTELLIGENT HOUSE WITHIN YOUR REACH

---

An intelligent house requires the application of appropriate technology. SMART VIDOK is an easy in-use system to provide remote control access to devices located in the house and its surroundings. It enables their mutual integration and full control. Managing roller blinds, windows, garage doors, front doors, facade shutters has never been so easy! Use our knowledge to be able to fully organize and save your time.

## NATURAL EXTENSION OF YOUR HAND

---

Using a touch screen, you can select, control, integrate, memorize and set up all the devices at home. With one movement, without any effort, you can precisely roll down the blinds half-way through in the bedroom, change the position of the shutters set-up, fully roll down the awning on the patio or open/close the entrance gate.



pilot Nina



piloty Situo

## TAKE CARE OF THE DETAILS

---

The common feature of all roller blinds systems is matching the designs of all visible elements in the rooms. A wide selection of controlling devices matches the interior design of each room.



Tahoma Box

## TAHOMA BOX

---

TaHoma Box is the brain of the SMART VIDOK system. It enables communication with all VIDOK devices at home and its surrounding. The TaHoma Box module is connected to the home router and enables to control household devices from any place in the world using a computer, tablet or smartphone.





## SCREEN ROLLER BLINDS

### A COVER FOR YOUR WINDOW

---

SCREEN fabric roller blinds are a modern covering product, installed on the external part of the window or a glass wall, similar to classic roller blinds. Creating a barrier to excessive sun exposure, they provide optimal, visual and thermal comfort, at the same time acting as protection against insects and wind. They provide freedom, intimacy and protection of your private zone, staying for the whole time in harmony with the surroundings.

SCREEN roller blinds are weather resistant and practically they do not require care. Handling is easy and comfortable due to the electric drive. These roller blinds enable effective window darkening, as well as whole glass surfaces in all types of residential or public buildings, becoming a unique decoration element.



## FACADE SHUTTERS

### SUN MANAGEMENT

---

Facade shutters are an element following the trends of modern architecture. They perfectly integrate the interior with the outside world, influencing the visual aesthetics, provide intimacy and comfort.

A light and simple construction of the shutters perfectly integrates with the buildings of modern constructions. Facade shutters protect the interiors against excessive heat, reducing the use of air conditioning devices and this way contributing to the decrease of the running costs of the building. They allow to obtain an appropriate light and shade balance, minimalizing light reflexes.

Facade shutters laths, made of high quality aluminum, are very durable and resistant to corrosion. A wide range of colors underlines an individual character of each facade.









## HANDLES

### EVERYTHING UNDER CONTROL

---

A handle is much more than just any handle. It is a distinctive feature for your window, an exceptional element of style, which improves its aesthetics and gives it an individual character. The forms and colors create an abundance of possibilities, both in classical and modern styles. Our handles are characterized by high durability and reliability. They improve security and comfort of handling windows. Apart from handles in a standard version, we also have lockable handles, with a Secustik button and Tilt-First.

#### SWING



R 05.3

R 05.5

R 03.2

R 01.3

R 01.2

#### CLASSIC



#### MODERN



RAL 9005

RAL 7016

F4

F9

F1



# GLAZING

---

The main purpose of window glass is not only letting the daylight inside the building, but, protecting the rooms against the heat loss, noise and burglary, at the same time providing comfort and security.

## THERMAL INSULATION GLASS

---

The main purpose for using insulated glass units is the thermal protection. The insulating glass consists of at least two single glass units and a varied width of the spacer frames. Not only the thickness of the glass, but also special low-emission coats, the space between glass units and gas filling regulate the value of the U coefficient, which is the thermal insulation parameter.

## ACOUSTIC INSULATION GLASS

---

The constantly increasing population, industry development and traffic density has an impact on the noise increase. Numerous studies prove the harmful effect it has got on health and quality of life. Achieving an increased sound insulation is possible thanks to using the right glass package made of laminated glass with a widened spacer frame and an asymmetric glass construction.

## SAFE GLASS

---

Providing the right level of security is extremely important in the designing process and investment realization. Toughened safety glass (ESG) consists of a special glass unit which undergoes thermal processing. Smashing it leads to breaking the glass panel into little pieces of blunt edges. Safely laminated glass (VSG) is created as a result of gluing two glass panels permanently using special foil (most often clear or milky color). While smashed, the glass does not get shattered, but it is kept on the foil. The foil of the right thickness may perform an anti-burglary and construction function.

## ORNAMENTAL GLASS

---

Ornaments perform mainly a decorative function. The level of glass transparency depends on the pattern, glass color and possible additional processing (e.g. a sanded surface). The ornament gently scatters the light, at the same time giving a sense of privacy.







# FROM PRODUCTION, THROUGH INSTALLATION, UP TO THE SERVICE

---

## CONSULTANCY

---

Receive a professional and technical consultancy as well as technical support from our specialists. We shall adjust our solutions to your needs.

## TIMELY DELIVERY

---

We guarantee a timely delivery of windows and doors. Our products are reliable and they reach the agreed destination on time due to the ideally planned logistics.

## PLANNING AND MEASUREMENT

---

There is a possibility to receive consultancy, measurement and professional advice from our technical specialist in your house or on the construction site.

## PROFESSIONAL INSTALLATION

---

We provide professional installation in compliance with the current technical requirements and norms of the construction law. It is a key to our success.

## INVOLVEMENT

---

From the design stage we provide support with our knowledge and experience by personal involvement of each employee. Our experts realize each project with passion.

## COMPLEX SERVICE

---

Our 25-year-experience is reflected in the high quality of maintenance services. We constantly improve qualifications of our employees. Our success can be measured by millions of satisfied customers. Beginning with the design and finishing with an efficient service.

---

## CERTIFICATES AND AWARDS



## OUR PARTNERS



---

## IMPRESSUM

VIDOK Sp. z o.o. Rudna Mała 75  
36-054 Mrowla  
Poland

Phone.: +48 17 859 56 60  
Fax: +48 17 859 56 61

E-mail: [biuro@vidok.com](mailto:biuro@vidok.com)

[www.vidok.com](http://www.vidok.com)

KRS No. 0000191980  
REGON: 690379060  
NIP: 813-10-86-710

The foregoing publication does not constitute an offer within the meaning of art. 6 of the Civil Code. VIDOK Sp. z o.o. reserves the right to change and improve products presented in the foregoing catalogue. Information included in the catalogue is valid at the time of publishing it. Due to the restrictions of the printing technique, the colours of the presented products may vary from the real ones.

© Copyright by VIDOK Sp. z o.o.

WINDOWS | DOORS | FACADES | BLINDS



 **VIDOK.COM**  
WINDOWS AND DOORS